

Coffee Solutions mini-catalog



DISPENSE-RITE®

E.D.A. International Corp.
sales@edainternational.com

Bestsellers - Stock Recommendations

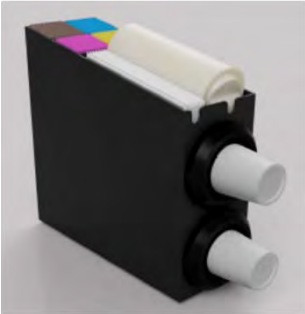

Cafecito



SLR-1 & SLR-2



LID-4BT



CTBH-8BT



CTVH-4BT



SLV-10BT



VSCH-6BT



LID-3BT



NLO-1B



SLR-LID-2



SWCH-1BT



(2)ADJ-NW + TLD-2-2+EZ-3EZ



MCD-6BT



WR-CT3



ADJ-1 & ADJ-2



DLCO-5BT



NLO-CTVL



CTLD-15 & CTLD-22



TTC-2BT & TTC-3BT



SLR-S-3BT



LID2-S2-2BT



ADJ-NS-31, -81, -101



WR-CT-4/WR-CT-LID



SLR-SCL-1BT

E.D.A. International Corp.



Introducing our new ultra-compact countertop cup dispenser!

Cafecito:

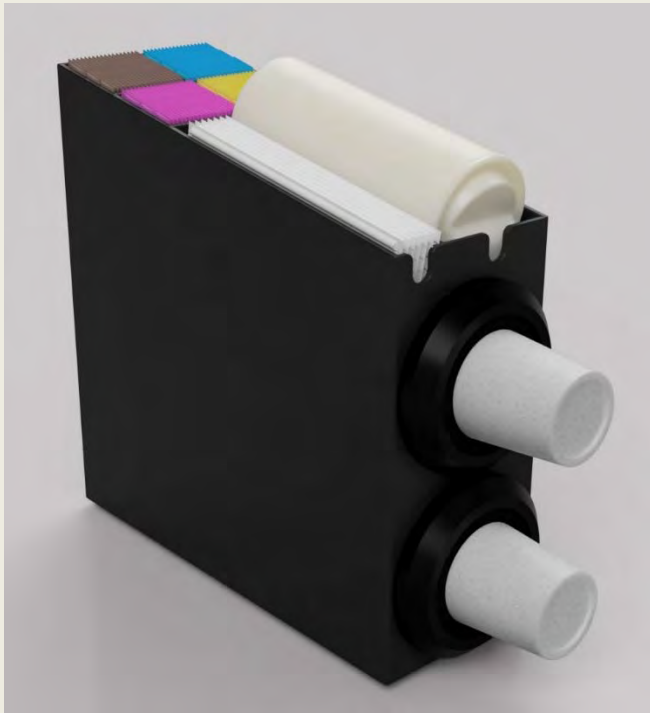

This ultra -compact Countertop Cup & Lid Dispensing Cabinet features SLR-1S baffle-type cup dispensers combined with a durable and stylish polystyrene cabinet specifically designed for limited space applications in coffee shops, cafes, coffee stations, smaller c-stores, and food courts. Unique cabinet design incorporates a high impact ABS plastic top to provide storage for lids, straws, stir-sticks and condiment packets.

Model Number	Number of SLR-1S dispensers	Cup Sizes	Cup Rim Diameter Range	Dimensions
Cafecito (SLR-SL1-2BT)	2	4 - 24 oz (118 ml - 710 ml)	2-1/2" - 3-7/8" (64mm - 99mm)	6-3/4"w x 17-1/4"d x 17-1/4"high (171mm w x 438mm d x 438mm h)

Contact us for more information!

E.D.A. International Corp.

4907 SW 75th Ave.

Miami, FL 33155 , USA

Phone: (305) 669-1894 / Fax: (305) 669-1797

e-mail : sales@edainternational.com

www.edainternational.com

Visit our website to learn about all of our product offerings!_

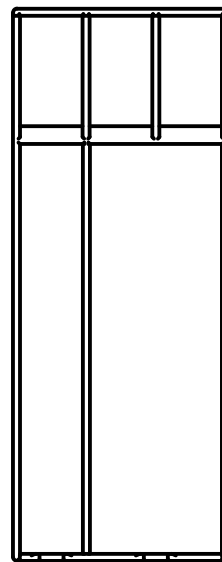

6 ³/₄

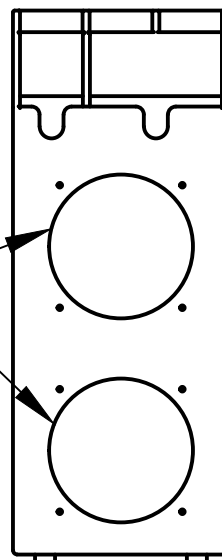

SLR-1S
MOUNTS (x2)

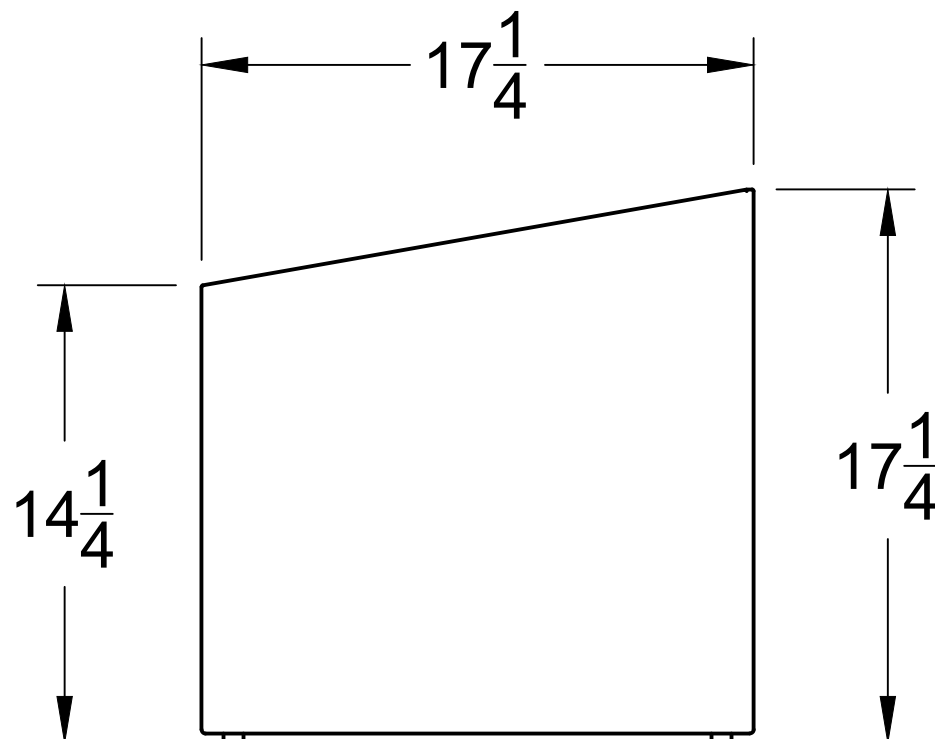

Export Representatives:
E.D.A. International Corp.
 4907 SW 75th Ave.
 Miami, FL 33155 , USA
 Phone: (305) 669-1894 / Fax: (305) 669-1797
 e-mail : sales@edainternational.com
 www.edainternational.com

		PROJECT		
		Dispense-Rite		
		TITLE		
		Cafecito (SLR-SL1-2BT)		
APPROVED	SIZE	CODE	DWG NO	REV
CHECKED	B			
DRAWN	Ron Klein	4/18/2023	SCALE 1:6	WEIGHT
				SHEET 1/1

SELF ADJUSTING DISPENSING FLEXIBILITY

SLR SERIES IN-COUNTER INTERCHANGEABLE BAFFLE CUP DISPENSERS

DISPENSE-RITE SLR Series cup dispensers feature quality ABS plastic construction combined with an interchangeable silicone baffle gasket system to accommodate a full range of cup sizes from 4 oz. to 44 oz.

A calibrated compression spring ensures one at a time dispensing in horizontal, angled or vertical mounting positions. The integrated mounting collar fully supports the dispenser in horizontal, angled or vertical mounting positions; no additional support is necessary. All models are NSF listed.

DISPENSE-RITE
interchangeable baffle
gasket system



The **SLR-1** is a **Slim-Line** model that is ideal for smaller cup sizes and tight spaces. The SLR-1 accepts 4 oz. to 24 oz. paper, plastic or foam cups with rim diameters from 2½"–3⅞". The SLR-1 model requires a 4½" hole cut-out and is great for many retrofit applications as it combines dispensing flexibility with space savings.



The **SLR-2** is a **One-Size-Fits-All** model that offers maximum dispensing flexibility. This dispenser is designed to accommodate a variety of 8 oz. to 44 oz. paper, plastic or foam cups with rim diameters ranging in size from 3"–4½". This model comes in three under counter lengths: 22", 17" and 28". The SLR-2 models require a 5¼" hole.



Model Number	Cup Rim Diameter Range	Under Counter Length	Ring Bezel Diameter	Mounting Hole Cut-Out
SLR-1	2½"–3⅞"	22"	6⅞"	4½"
SLR-1S	2½"–3⅞"	17"	6⅞"	4½"
SLR-2	3"–4½"	22"	7⅞"	5¼"
SLR-2S	3"–4½"	17"	7⅞"	5¼"
SLR-2L	3"–4½"	28"	7⅞"	5¼"

ABS PLASTIC CONSTRUCTION

▽ IN-COUNTER INTERCHANGEABLE BAFFLE CUP DISPENSERS

SLR-1 AND SLR-1S SLIM-LINE
IN-COUNTER INTERCHANGEABLE BAFFLE CUP DISPENSERS

The SLR-1 accepts a variety of 4 oz. to 24 oz. paper, plastic or foam cups with rim diameters from 2½"–3⅞". This model requires a 4½" hole cut-out and is great for many retrofit applications as it combines dispensing flexibility with space savings.



Spring Configurations ▽

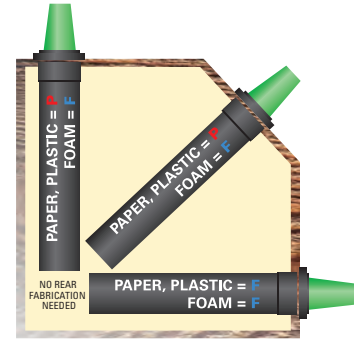

Cup Type	Position	Spring
Foam Cups	: Any Position	: F Spring
Paper Cups	: Horizontal	: F Spring
Plastic Cups	: Horizontal	: F Spring
Paper Cups	: Angled	: P Spring
Plastic Cups	: Angled	: P Spring
Paper Cups	: Vertical	: P Spring
Plastic Cups	: Vertical	: P Spring

Dispensers ship with both the "F" and "P" compression springs.

Single spring models are available; see price list for additional information.

Color Ring Bezels ▽

Optional colored ring bezels are available for SLR-2 Series cup dispensers in this popular color:



- SILVER SATIN (stainless faux finish)

Under Counter Bracket ▽

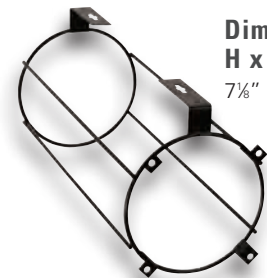

Dimensions
H x W x D
7½" x 6" x 15¼"

The optional **STL-2-SMB** wire surface mount bracket mounts to any flat surface or wire shelf and allows you to mount a SLR-2 cup dispenser in horizontal, vertical or angled positions. Maximum counter lip is 1/2".

SLR-2, SLR-2S AND SLR-2L ONE-SIZE-FITS-ALL
IN-COUNTER INTERCHANGEABLE BAFFLE CUP DISPENSERS

These dispensers accommodate a variety of 8 oz. to 44 oz. paper, plastic or foam cups with rim diameters ranging in size from 3"–4½". The SLR-2 models require a 5¼" hole.

With three under counter lengths to choose from the SLR-2 cup dispenser can be ordered to suit your particular installation requirements.

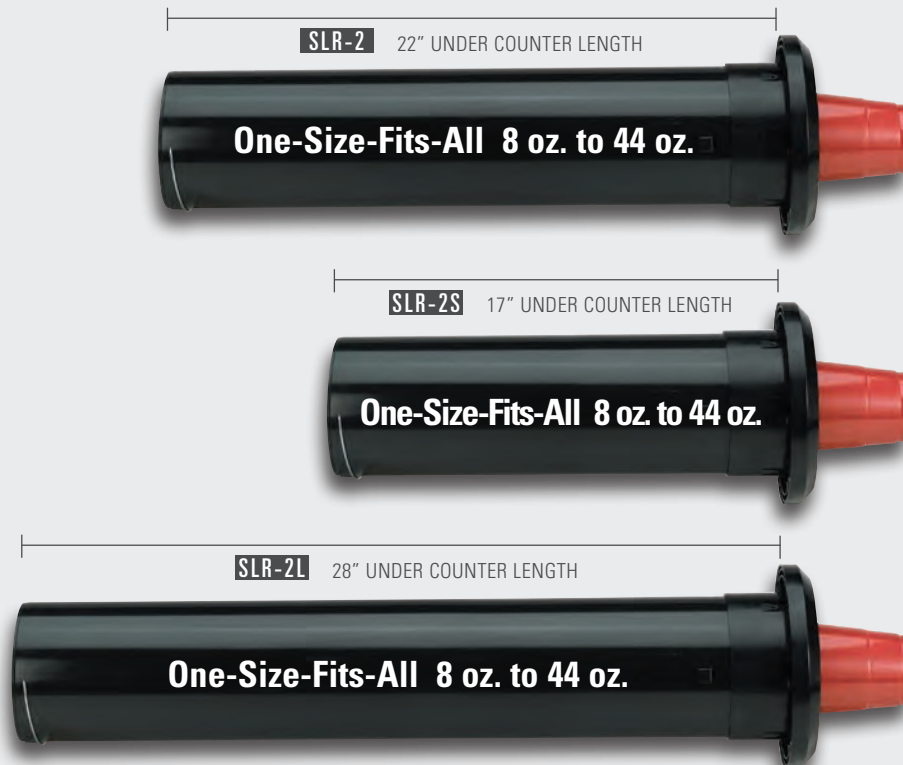

▽ ONE-SIZE-FITS-ALL CUP DISPENSING CABINETS

BLACK POLYSTYRENE CONSTRUCTION



SLR-S-2BT



SLR-S-3BT



SLR-S-4BT

The **SLR-S Series** Countertop Cup Dispensing Cabinets feature SLR-2 cup dispensers combined with a durable and stylish polystyrene cabinet.

Cabinets dispense a variety of 8 oz. to 44 oz. paper, plastic or foam cups with rim diameters ranging in size from 3" – 4½".

Model Number	Number of SLR-2 Dispensers	Cup Sizes	Cup Rim Diameter Range	Cabinet Dimensions H x W x D
SLR-S-2BT	2	8 to 44 oz.	3" – 4½"	16¼" x 8" x 23"
SLR-S-3BT	3	8 to 44 oz.	3" – 4½"	24¼" x 8" x 23"
SLR-S-4BT	4	8 to 44 oz.	3" – 4½"	32¼" x 8" x 23"



SLR-SL-2BT



SLR-SL-3BT



SLR-SL-2X2BT

The **SLR-SL Series** Countertop Cup & Lid Dispensing Cabinets feature SLR-2 cup dispensers combined with a durable and stylish polystyrene cabinet.

Unique cabinet design incorporates a high impact ABS plastic top to provide storage for lids, straws, stir-sticks and condiment packets.

Model Number	Number of SLR-2 Dispensers	Cup Sizes	Cup Rim Diameter Range	Cabinet Dimensions H x W x D
SLR-SL-2BT	2	8 to 44 oz.	3" – 4½"	22¼" x 8½" x 24"
SLR-SL-3BT	3	8 to 44 oz.	3" – 4½"	29¼" x 8½" x 24"
SLR-SL-2X2BT	4	8 to 44 oz.	3" – 4½"	22¼" x 16½" x 24"

▽ ONE-SIZE-FITS-ALL CUP DISPENSING CABINETS

SLR
SERIES

The **SLR-C Series** Countertop Combination Dispensing Cabinets feature SLR-2 cup dispensers and include built-in storage for lids and straws.

These dispensing cabinets are constructed from a durable black polystyrene material.

Cabinets dispense a variety of 8 oz. to 44 oz. paper, plastic or foam cups with rim diameters ranging in size from 3" – 4½". Straw compartment accommodates standard and jumbo length straws.

Model Number	Location of SLR-2 Dispensers	Cup Sizes	Cup Rim Diameter Range	Cabinet Dimensions H x W x D
SLR-C-3RBT	Right	8 to 44 oz.	3" – 4½"	24¼" x 13" x 23"
SLR-C-3LBT	Left	8 to 44 oz.	3" – 4½"	24¼" x 13" x 23"
SLR-C-4RBT	Right	8 to 44 oz.	3" – 4½"	32¼" x 13" x 23"
SLR-C-4LBT	Left	8 to 44 oz.	3" – 4½"	32¼" x 13" x 23"



SLR-C-3RBT



SLR-C-3LBT



SLR-C-4RBT



SLR-C-4LBT

Key Features ▽

- ONE-SIZE-FITS-ALL
- 8 oz. to 44 oz. Cup Sizes
- Angled Lid Compartments
- High Capacity Straw Organizer
- Simple and Fast Adjustment
- Paper, Plastic or Foam Cups
- No-Jam Design
- NSF Listed Cup Dispensers

Cup Sizing Chart ▽

The SLR Series accommodate a variety of cup sizes ranging from 8 oz. to 44 oz. Always verify cup rim diameter prior to ordering.

SIZE-RITE

MODEL	APPROX CUP SIZE
SLR-C-3RBT	8 oz. to 44 oz.
SLR-C-3LBT	8 oz. to 44 oz.
SLR-C-4RBT	8 oz. to 44 oz.
SLR-C-4LBT	8 oz. to 44 oz.

Included Cup Dispensers ▽

The **DISPENSE-RITE** SLR-2 cup dispenser is included with these cabinet models.



See pages 12–13 for additional details.

BLACK POLYSTYRENE CONSTRUCTION

ADJ-1 AND ADJ-1.50 SLIM-LINE CUP DISPENSERS

The ADJ-1 is designed to accommodate 4 oz. to 12 oz. paper, plastic or foam cups with rim diameters ranging in size from 2½"–3½". The ADJ-1.50 is designed to accommodate 8 oz. to 24 oz. paper, plastic or foam cups with rim diameters ranging in size from 3"–3¾".



ADJ-2 AND ADJ-2S ONE-SIZE-FITS-ALL CUP DISPENSERS

These dispensers are designed to accommodate a variety of 8 oz. to 44 oz. paper, plastic or foam cups with rim diameters ranging in size from 3"–4½".

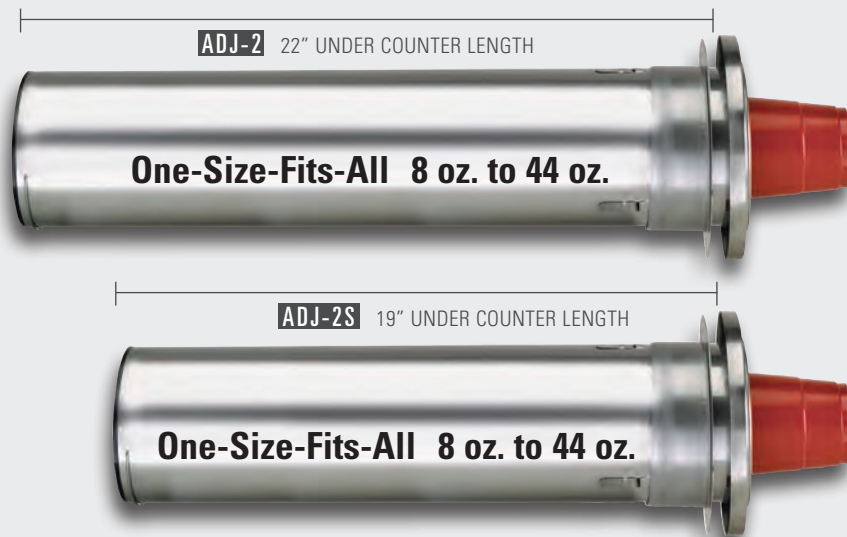

ADJ-3 JUMBO-SIZE CUP DISPENSERS

This dispenser is designed to accommodate 44 oz. to 64 oz. paper, plastic or foam cups with rim diameters ranging in size from 4½"–5¼".



Spring Configurations ▽

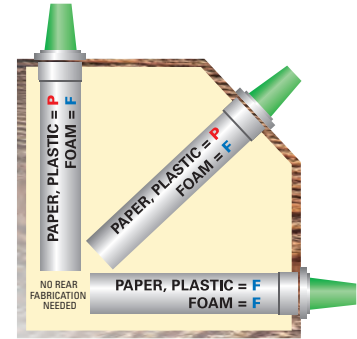

Cup Type	Position	Spring
Foam Cups	: Any Position	: F Spring
Paper Cups	: Horizontal	: F Spring
Plastic Cups	: Horizontal	: F Spring
Paper Cups	: Angled	: P Spring
Plastic Cups	: Angled	: P Spring
Paper Cups	: Vertical	: P Spring
Plastic Cups	: Vertical	: P Spring

Dispensers ship with both the "F" and "P" compression springs.

Single spring models are available; see price list for additional information.

Color Ring Bezels ▽

Stainless ring bezels are standard on all models. Optional gloss black powder coated ring bezels are available for ADJ-2 Series cup dispensers.

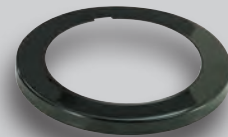

- **BUMPER BLACK** (high gloss)
Available only for the ADJ-2 and ADJ-2S models

Under Counter Bracket ▽

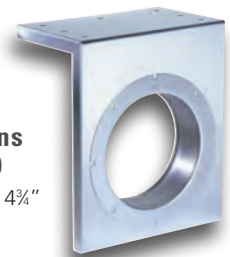

Dimensions
H x W x D
9¼" x 7¾" x 4¾"

The optional **UCMB-2** stainless steel under counter bracket mounts to any flat surface or wire shelf creating a face plate to mount an ADJ-2 cup dispenser. Maximum counter lip is 1¾".

STAINLESS STEEL CONSTRUCTION

LID DISPENSING FLEXIBILITY SIMPLIFIED

ABS PLASTIC CONSTRUCTION

DISPENSE-RITE
lid dispenser design
requires no adjustment
and provides easy one
handed operation



SLR-LID-2

SLR-LID-2 SERIES IN-COUNTER SPRING-LOADED LID DISPENSERS

DISPENSE-RITE SLR-LID-2 Series lid dispensers are designed to combine simplicity with dependability for long-term reliability and maximum cost savings.

This sanitary beverage lid dispenser requires no adjustment and is available for a variety of in-counter and countertop applications. Lid stacks are enclosed to protect from potential contamination due to spills, splashes and sneezes. All parts are easily removable for simple cleaning. NSF Listed.

IMPORTANT INFORMATION ON LID COMPATIBILITY

DISPENSE-RITE SLR-LID-2 Series Lid Dispensers are primarily intended for use with flat, cold beverage lids. Lids that are tightly nested or have deep extrusions may not be compatible. To confirm lid compatibility please contact a DISPENSE-RITE representative and provide a full sleeve of lids for testing prior to ordering.



SLR-STRAW-2 IN-COUNTER STRAW ORGANIZER

The SLR-STRAW-2 in-counter straw organizer holds standard and jumbo length straws. These straw organizers look great with any SLR Series lid or cup dispenser. All parts are easily removable for simple cleaning. NSF Listed.

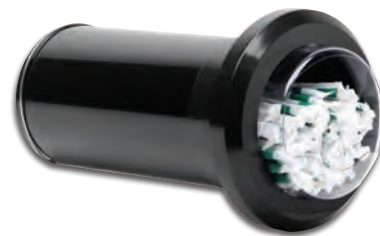

SLR-STRAW-2

Model Number	Maximum Lid Diameter	Under Counter Length	Ring Bezel Diameter	Mounting Hole Cut-Out
SLR-LID-2	4 5/8"	22"	7 1/8"	5 1/4"
SLR-LID-2S	4 5/8"	17"	7 1/8"	5 1/4"
SLR-STRAW-2	-	12"	7 1/8"	5 1/4"

▽ COUNTERTOP LID, CUP & STRAW DISPENSING CABINETS



LID2-S1-2BT



LID2-S1-3BT



LID2-S2-2BT



LID2-S2-3BT

SLR-LID-2 SERIES COUNTERTOP LID, CUP & STRAW DISPENSING CABINETS

Countertop dispensing cabinets combine lid, cup and straw dispensers with a durable and stylish black polystyrene housing.

Cabinets dispense 8 oz. to 44 oz. paper, plastic or foam cups and lids with rim diameters ranging in size from 3" – 4½". Not all lids are compatible.

Model Number	Number of Dispensers	Cup / Lid Sizes	Cup / Lid Rim Diameter Range	Cabinet Dimensions H x W x D
LID2-S1-2BT	2	8 to 44 oz.	3" – 4½"	16¼" x 8" x 23"
LID2-S1-3BT	3	8 to 44 oz.	3" – 4½"	24¼" x 8" x 23"
LID2-S2-2BT	2	8 to 44 oz.	3" – 4½"	24¼" x 8" x 23"
LID2-S2-3BT	3	8 to 44 oz.	3" – 4½"	24¼" x 8" x 23"

▽ COUNTERTOP STACKABLE CUP, LID & STRAW ORGANIZERS



STK Series products can be stacked on top of each other to create a variety of custom cup, lid, straw and condiment dispensing configurations



NLO-STK-1BT



SLR-STK-1BT



LID-STK-1BT



STR-STK-1BT

STK SERIES COUNTERTOP STACKABLE CUP, LID, STRAW & CONDIMENT ORGANIZERS

Modular stackable cabinet design allows for a variety of configurations of countertop cup, lid, straw and condiment dispensers. Short cabinet depth is ideal for use in areas with limited space.

The SLR-STK-1BT includes an SLR-2S to accommodate a variety of 8 oz. to 44 oz. paper, plastic or foam cups with rim diameters ranging from 3"–4½". Not all lids are compatible with LID-STK-1BT.

Model Number	Item Description	Dimensions H x W x D
NLO-STK-1BT	Stackable Lid, Straw & Condiment Organizer	7½" x 8" x 19½"
SLR-STK-1BT	Stackable Cup Dispensing Cabinet with (1) SLR-2S	8¼" x 8" x 18½"
LID-STK-1BT	Stackable Lid Dispensing Cabinet with (1) SLR-LID-2S	8¼" x 8" x 18½"
STR-STK-1BT	Stackable Straw Dispensing Cabinet with (1) SLR-STRAW-2	8¼" x 8" x 18½"

▽ **SURFACE OR STAND MOUNTED CUP DISPENSERS**

ADJ-NW & ADJ-NS ADJUSTABLE CUP DISPENSERS

Simple and fast adjustment of five stainless steel models will accurately dispense cups with rim diameters ranging in size from 2⁵/₈"–4³/₄".

To select the correct model dispenser please measure the top rim diameter of your cup and refer to the sizing chart on the right.

ADJ-NW Series Cup Dispensers are pull-type (gravity feed) and are intended for use in vertical or angled mounting positions.

ADJ-NS Series Cup Dispensers are spring-loaded and are intended for use in horizontal or vertical mounting positions.

Dispensers are shipped with two sets of stainless steel mounting brackets and can be mounted to a wall or surface. A countertop stand is also available (see page 37).

All cup dispenser models are NSF listed.

Model Number	Cup Rim Diameter Range	Tube Diameter	Tube Length	Paper/Plastic Cup Sizes	Foam Cup Sizes
PULL -TYPE SURFACE OR STAND MOUNTED CUP DISPENSERS					
ADJ-NW-21	2 ⁵ / ₈ "–3 ³ / ₃₂ "	3 ⁵ / ₁₆ "	25 ¹ / ₂ "	6 oz. to 12 oz.	6 oz. to 8 oz.
ADJ-NW-31	2 ⁷ / ₈ "–3 ¹ / ₂ "	3 ¹¹ / ₁₆ "	25 ¹ / ₂ "	12 oz. to 22 oz.	8 oz. to 12 oz.
ADJ-NW-81	3 ¹ / ₄ "–3 ⁷ / ₈ "	4 ¹ / ₈ "	25 ¹ / ₂ "	14 oz. to 24 oz.	12 oz. to 24 oz.
ADJ-NW-101	3 ³ / ₄ "–4 ⁵ / ₁₆ "	4 ⁵ / ₈ "	25 ¹ / ₂ "	32 oz.	32 oz.
ADJ-NW-151	4 ¹ / ₈ "–4 ³ / ₄ "	4 ⁷ / ₈ "	25 ¹ / ₂ "	44 oz.	32 oz. to 44 oz.
SPRING-LOADED SURFACE OR STAND MOUNTED CUP DISPENSERS					
ADJ-NS-21	2 ⁵ / ₈ "–3 ³ / ₃₂ "	3 ⁵ / ₁₆ "	25 ¹ / ₂ "	6 oz. to 12 oz.	6 oz. to 8 oz.
ADJ-NS-31	2 ⁷ / ₈ "–3 ¹ / ₂ "	3 ¹¹ / ₁₆ "	25 ¹ / ₂ "	12 oz. to 22 oz.	8 oz. to 12 oz.
ADJ-NS-81	3 ¹ / ₄ "–3 ⁷ / ₈ "	4 ¹ / ₈ "	25 ¹ / ₂ "	14 oz. to 24 oz.	12 oz. to 24 oz.
ADJ-NS-101	3 ³ / ₄ "–4 ⁵ / ₁₆ "	4 ⁵ / ₈ "	25 ¹ / ₂ "	32 oz.	32 oz.
ADJ-NS-151	4 ¹ / ₈ "–4 ³ / ₄ "	4 ⁷ / ₈ "	25 ¹ / ₂ "	44 oz.	32 oz. to 44 oz.

STAINLESS STEEL CONSTRUCTION

PULL-TYPE DISPENSERS



SPRING-LOADED DISPENSERS



▽ SURFACE OR STAND MOUNTED LID DISPENSERS

TLD SERIES TUBULAR LID DISPENSERS

Stainless steel lid dispensers mount to a wall or surface or they can be attached to the EZ-3EZ countertop stand.

Dispensers are shipped with two sets of stainless steel mounting brackets and hardware. The brackets can be attached to the rear or side of the unit for multiple installation options.

Model Number	Max Lid Rim Diameter	Max Lid Size	Tube Diameter	Tube Length	Number of Lid Sections
SURFACE OR STAND MOUNTED TUBULAR LID DISPENSERS					
TLD-2-2	4 $\frac{1}{8}$ "	6 oz. to 24 oz.	4 $\frac{1}{4}$ "	25 $\frac{1}{2}$ "	2
TLD-3-3	4 $\frac{3}{4}$ "	12 oz. to 44 oz.	4 $\frac{7}{8}$ "	25 $\frac{1}{2}$ "	3



DISPENSE-RITE cup and lid dispensers include mounting brackets for attaching to walls or any flat surface.

Cup and lid dispensers can also be stand mounted to the EZ-3EZ countertop stand as shown here.



TLD-2-2

TLD-3-3

STAINLESS STEEL CONSTRUCTION

▽ COUNTERTOP STAND FOR CUP & LID DISPENSERS



EZ-3EZ

EZ-3EZ COUNTERTOP DISPENSING STAND

The EZ-3EZ countertop stand can be used with three ADJ-NW Series cup dispensers and/or TLD Series lid dispensers. When ordering please specify the proper cup or lid dispenser models required for your particular cup and lid sizes.

Model Number	Maximum Number of Dispensers	Dimensions H x W x D
COUNTERTOP DISPENSING STAND FOR USE WITH ADJ-NW AND TLD SERIES		
EZ-3EZ	3	29" x 15" x 15"

▽ COUNTERTOP CUP & LID ORGANIZERS

BLACK POLYSTYRENE CONSTRUCTION



The optional MSH-1 acrylic straw and condiment holder can be inserted into any section on the LID Series countertop organizers to accommodate straws, stir sticks or packeted condiments.

LID-3BT and LID-5BT organizers shown at left with optional MSH-1 straw and condiment holder.



MSH-1



LID-3BT



LID-4BT



LID-5BT

MAXIMUM DISPENSING IN A MINIMUM AMOUNT OF SPACE

LID SERIES COUNTERTOP CUP & LID ORGANIZERS

Countertop cup & lid organizers accommodate 6 oz. to 44 oz. paper, plastic or foam cups and lids with rim diameters ranging from 2 5/8" – 4 3/4".

Countertop units feature durable polystyrene construction. Compact design requires only 5 1/4" W of countertop space. The LID Series are NSF listed.

The optional MSH-1 straw and condiment holder can be inserted into any section for storing straws, stir sticks or packeted condiments.

Model Number	Item Description	Dimensions H x W x D
LID-3BT	3 Section Lid & Cup Organizer	16 1/2" x 5 1/4" x 17"
LID-4BT	4 Section Lid & Cup Organizer	19 1/2" x 5 1/4" x 20 3/4"
LID-5BT	5 Section Lid & Cup Organizer	23" x 5 1/4" x 24 1/2"
MSH-1	Modular Straw & Condiment Holder	6" x 4" x 4"

▽ COUNTERTOP CUP, LID, STRAW & CONDIMENT ORGANIZERS



DLCO-5BT



HLCO-3BT

LCO SERIES COUNTERTOP CUP, LID, STRAW & CONDIMENT ORGANIZERS

These versatile countertop polystyrene organizers offer an easy way to organize cups, lids, straws and condiments. Countertop units feature durable polystyrene construction.

Model Number	Item Description	Dimensions H x W x D
DLCO-5BT	6 Section Multipurpose Organizer	16¾" x 20¾" x 5½"
HLCO-3BT	8 Section Multipurpose Organizer	11¾" x 17" x 7½"

▽ COUNTERTOP CUP, LID, STRAW & CONDIMENT ORGANIZERS



MCD-4BT



MCD-6BT



The MCD-4BT and MCD-6BT organizers include removable front panels that allow the unit to be configured for a variety of dispensing applications.

MCD SERIES COUNTERTOP CUP, LID, STRAW & CONDIMENT ORGANIZERS

These versatile countertop polystyrene organizers offer an easy way to organize cups, lids, straws and condiments. MCD Series organizers include removable front panels for a variety of custom dispensing configurations.

Model Number	Item Description	Dimensions H x W x D
MCD-4BT	4 Section Multipurpose Organizer	11¾" x 10½" x 10"
MCD-6BT	6 Section Multipurpose Organizer	11¾" x 15" x 10"

▽ LID, STRAW & CONDIMENT ORGANIZERS WITH REMOVABLE DIVIDERS

BLACK POLYSTYRENE CONSTRUCTION



NLO-1B



WLO-1B

MAXIMUM ORGANIZATION IN A MINIMUM AMOUNT OF SPACE

The **NLO-1B** & **WLO-1B** models feature durable polystyrene construction and offer an easy way to organize lids, straws or condiments. Some section dividers are removable for custom dispensing configurations.

These units offer maximum organization in a minimum amount of countertop space.

Model Number	Item Description	Dimensions H x W x D
NLO-1B	Black Polystyrene Narrow Organizer	16½" x 8" x 20½"
WLO-1B	Black Polystyrene Wide Organizer	16½" x 15" x 20½"

▽ LID, STRAW & CONDIMENT ORGANIZERS



NLO-WVL



NLO-CTVL



MICRO-1

Ideal for use when space is limited.

The **NLO-WVL**, **NLO-CTVL** & **MICRO-1** models are designed with multiple sections for custom configuration. All organizers feature durable polystyrene construction.

The **MICRO-1** model is ideal for applications where countertop space is limited.

Model Number	Item Description	Dimensions H x W x D
NLO-WVL	Black Polystyrene Organizer	20¼" x 11½" x 21¼"
NLO-CTVL	Black Polystyrene Organizer	20" x 13½" x 22½"
MICRO-1	Black Polystyrene Organizer	4⅝" x 8" x 11⅞"

▽ LID, STRAW & CONDIMENT ORGANIZERS

NLS
SERIES

BLACK POLYSTYRENE CONSTRUCTION



NLS-1BT



WLS-1BT



NSLC-1BT

The **NLS-1BT**, **WLS-1BT** & **NSLC-1BT** models feature a sleek design and an easy to clean ABS plastic top. All organizers feature durable polystyrene construction.

The NSLC-1BT model includes a stainless steel CMND-1 napkin dispenser which accommodates full fold napkin sizes ranging from 4½"–5" x 6½".

Model Number	Item Description	Dimensions H x W x D
NLS-1BT	Black Polystyrene Narrow Organizer	9½" x 8½" x 23½"
WLS-1BT	Black Polystyrene Wide Organizer	9½" x 16½" x 23"
NSLC-1BT	Black Polystyrene w/Napkin Dispenser	15¾" x 8½" x 24½"

▽ LID, STRAW & CONDIMENT ORGANIZERS

NLS
SERIES

STAINLESS STEEL CONSTRUCTION



NLS-1

accepts up to
64 oz. lids



WLS-1

The **NLS-1** & **WLS-1** models feature stainless steel welded construction and an easy to clean ABS plastic top. The models are ideal for merchandising single-serve coffee, tea and hot chocolate packets or simply organizing lids, straws, stir sticks and condiments.

Model Number	Item Description	Dimensions H x W x D
NLS-1	Stainless Steel Narrow Organizer	11½" x 8½" x 22¾"
WLS-1	Stainless Steel Wide Organizer	11½" x 16½" x 22¾"

▽ LID, STRAW, CONDIMENT & FLATWARE ORGANIZERS WITH NAPKIN DISPENSER



NLO-LDNH



NLO-ADNH



NLO-SWNH

NLO SERIES COUNTERTOP LID, STRAW, CONDIMENT, NAPKIN & FLATWARE ORGANIZERS

Countertop units feature durable polystyrene construction. These unique units offer maximum organization in a minimum amount of space.

The CT-FULL-BS full fold napkin dispenser accommodates napkin sizes 4½"-5" x 6½".

Model Number	Item Description	Dimensions H x W x D
NLO-LDNH	Multi-Purpose Polystyrene Organizer	14½" x 8½" x 17"
NLO-ADNH	Multi-Purpose Polystyrene Organizer	14½" x 8½" x 17"
NLO-SWNH	Organizer with Flatware Holders	14¾" x 10" x 17"

▽ COUNTERTOP BOTTLE HOLDERS



CTBH-4BT



CTBH-8BT



CTBH-12BT

CTBH SERIES COUNTERTOP BOTTLE HOLDERS

Countertop units feature durable polystyrene construction. Individual sections accommodate bottle sizes up to 3¾" diameter.

Multiple units can be placed next to each other to create additional custom configurations with additional capacity.

Model Number	Item Description	Dimensions H x W x D
CTBH-4BT	4 Section Bottle Holder	9½" x 6" x 17"
CTBH-8BT	8 Section Bottle Holder	9½" x 9½" x 17"
CTBH-12BT	12 Section Bottle Holder	9½" x 13¾" x 17"

BLACK POLYSTYRENE CONSTRUCTION



CTSH-6BT



CTSH-8BT



SWCH-1BT

CTSH & SWCH-1BT COUNTERTOP FLATWARE & CONDIMENT ORGANIZERS

Countertop units feature durable polystyrene construction. These unique units offer maximum organization in a minimum amount of space. All models include removable perforated plastic inserts. The SWCH-1BT organizer has removable section dividers for custom configurations.

Model Number	Item Description	Dimensions H x W x D
CTSH-6BT	6 Compartment Organizer	13" x 10 ¹ / ₈ " x 15 ³ / ₈ "
CTSH-8BT	8 Compartment Organizer	15 ³ / ₄ " x 10 ¹ / ₈ " x 18 ³ / ₄ "
SWCH-1BT	13 Compartment Multi-Purpose Organizer	16 ⁵ / ₈ " x 10" x 21"



VSCH-3BT



VSCH-6BT



VSCH-8BT

VSCH SERIES COUNTERTOP FLATWARE & CONDIMENT ORGANIZERS

Countertop units feature durable polystyrene construction. All models include removable perforated plastic inserts.

Multiple units can be placed next to each other to create additional custom configurations with additional capacity.

Model Number	Item Description	Dimensions H x W x D
VSCH-3BT	3 Compartment Organizer	21 ¹ / ₈ " x 6" x 9 ¹ / ₄ "
VSCH-6BT	6 Compartment Organizer	21 ¹ / ₈ " x 10 ¹ / ₂ " x 9 ¹ / ₄ "
VSCH-8BT	8 Compartment Organizer	28 ¹ / ₂ " x 10 ¹ / ₂ " x 9 ¹ / ₄ "

BLACK POLYSTYRENE CONSTRUCTION

▽ COUNTERTOP CUP, LID, STRAW & CONDIMENT ORGANIZERS



CLCO-2BT



CLCO-4BT

CLCO SERIES COUNTERTOP CUP, LID, STRAW & CONDIMENT ORGANIZERS

Countertop units feature durable polystyrene construction. These units can be used to organize cups, lids, condiments and straws or stir sticks.

The maximum acceptable cup or lid diameter is 4¼".

Model Number	Item Description	Dimensions H x W x D
CLCO-2BT	4 Compartment Cup & Lid Organizer	11½" x 9½" x 14½"
CLCO-4BT	8 Compartment Cup & Lid Organizer	11½" x 18¾" x 14½"

▽ COUNTERTOP VERTICAL CONDIMENT ORGANIZERS



CTVH-4BT

CTVH-5BT

CTVH SERIES COUNTERTOP VERTICAL CONDIMENT ORGANIZERS

Countertop units feature durable polystyrene construction. These unique units offer maximum organization in a minimum amount of space.

Organizers can be used to organize a variety of packeted condiments. Canisters can be placed on the top shelf of each unit.

Available with four or five sections these organizers require only 6 $\frac{1}{8}$ " W of countertop space.

High capacity organizers are ideal for use in large volume foodservice operations. Multiple units can be placed next to each other to create additional storage capacity.

Model Number	Item Description	Dimensions H x W x D
CTVH-4BT	4 Section Condiment Organizer	20 $\frac{3}{8}$ " x 6 $\frac{5}{8}$ " x 11 $\frac{1}{8}$ "
CTVH-5BT	5 Section Condiment Organizer	26 $\frac{3}{8}$ " x 6 $\frac{5}{8}$ " x 13 $\frac{1}{2}$ "

BLACK POLYSTYRENE CONSTRUCTION

▽ COUNTERTOP CUP, LID, STRAW & CONDIMENT ORGANIZER



SLR-SCL-1BT

SLR-SCL-1BT COUNTERTOP CUP, LID, STRAW & CONDIMENT ORGANIZER

Countertop combination cup, lid, straw & condiment organizer features durable polystyrene construction. Unique cabinet design incorporates an integrated top organizer to provide storage for lids, straws, stir-sticks and condiment packets.

The short cabinet depth and compact overall design makes this item ideal for areas with limited space. This item is great for breakrooms, kitchens, refreshment centers or a variety of portable dispensing applications.

The included SLR-2S cup dispenser is for use with 8 oz. to 44 oz. paper, plastic or foam cups with rim diameters ranging from 3"-4 $\frac{1}{2}$ ". Maximum acceptable lid diameter is 4 $\frac{1}{4}$ ". Maximum straw length is 9".

Model Number	Item Description	Dimensions H x W x D
SLR-SCL-1BT	Cup, Lid, Straw & Condiment Organizer	14 $\frac{1}{2}$ " x 9 $\frac{1}{2}$ " x 18 $\frac{1}{2}$ "

REINFORCED WELDED WIRE CONSTRUCTION

The optional WR-CT-LID insert is available for WR-CT Series cup dispensing racks. This polystyrene lid chute creates a storage area for lids up to 4 3/8" diameter. Multiple inserts can be utilized in a single dispensing rack.

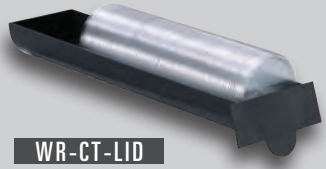

WR-CT-LID

WR-CT-4 shown with optional WR-CT-LID



WR-CT-3



WR-CT-4



WR-CT-5

MAXIMUM DISPENSING IN A MINIMUM AMOUNT OF SPACE

WR-CT SERIES CUP & LID DISPENSING RACKS

These units dispense 6 oz. to 44 oz. paper, plastic or foam cups with rim diameters ranging from 2 5/8" – 4 1/4". Features the simple and fast EZ-Twist adjustment mechanism. Reinforced welded construction and durable powder coated finish provide long term reliability.

The optional WR-CT-LID insert creates a storage area for lids up to 4 3/8" diameter.

Model Number	Item Description	Dimensions H x W x D
WR-CT-3	3 Section Vertical Dispensing Rack	19 1/4" x 6 1/4" x 20"
WR-CT-4	4 Section Vertical Dispensing Rack	24 3/4" x 6 1/4" x 20"
WR-CT-5	5 Section Vertical Dispensing Rack	29 3/4" x 6 1/4" x 20"
WR-CT-LID	1 Section Optional Lid Insert	3 1/4" x 6 1/8" x 20"



MAXIMUM DISPENSING IN A MINIMUM AMOUNT OF SPACE

PL-CT SERIES COUNTERTOP OR SURFACE MOUNT CUP & LID DISPENSING CABINETS

Cup Dispensing Cabinets accommodate 6 oz. to 44 oz. paper, plastic or foam cups with rim diameters ranging from 2½" – 4¾".

These unique spring-loaded models feature the simple and fast EZ-Twist adjustment mechanism. The divided straw compartment can be used for packeted condiments and/or stir sticks.

The PL-CT-LID lid and condiment organizer requires minimal countertop space. Compact design requires only 5½" W x 20¼" D of countertop space.

All PL-CT Series cup dispensing cabinets include key holes in the side panel for mounting to a vertical surface (mounting hardware is not included).

Model Number	Item Description	Dimensions H x W x D
PL-CT-LID	5 Section Lid & Condiment Organizer	17½" x 5½" x 19"
PL-CT-3BT	3 Section Cup Dispensing Cabinet	16¼" x 5½" x 20¼"
PL-CT-4BT	4 Section Cup Dispensing Cabinet	21¼" x 5½" x 20¼"
PL-CT-5BT	5 Section Cup Dispensing Cabinet	26¾" x 5½" x 20¼"

▽ COUNTERTOP LID & STRAW ORGANIZERS

TLO
SERIES

Model Number	Item Description	Dimensions H x W x D
TLO-2BT	2 Section Polystyrene Organizer	16¼" x 6½" x 14"
TLO-3BT	3 Section Polystyrene Organizer	24¼" x 6½" x 14"
TLO-4BT	4 Section Polystyrene Organizer	32¼" x 6½" x 14"

TLO SERIES COUNTERTOP LID & STRAW ORGANIZERS

Countertop lid and straw organizers feature durable polystyrene construction. Units include angled lid compartments and a divided section for standard and jumbo length straw or condiments. Available with two, three or four lid sections these cabinets occupy only 6½" x 14" of countertop space.

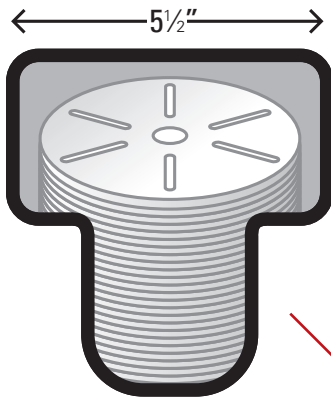

Maximum acceptable lid diameter is 5½"



TLO-2BT



TLO-3BT



TLO-4BT

BLACK POLYSTYRENE CONSTRUCTION

▽ **COUNTERTOP OR SURFACE MOUNT CUP, LID & STRAW ORGANIZERS**

STAINLESS STEEL CONSTRUCTION

Model Number	Item Description	Dimensions H x W x D
CTLD-15	3 Section Adjustable Organizer	8" x 15½" x 5"
CTLD-15A	3 Section Adjustable Organizer with SH-1	8" x 19⅝" x 5"
CTLD-19	4 Section Adjustable Organizer	8" x 19½" x 5"
CTLD-19A	4 Section Adjustable Organizer with SH-1	8" x 23⅝" x 5"
CTLD-22	5 Section Adjustable Organizer	8" x 22½" x 5"
CTLD-22A	5 Section Adjustable Organizer with SH-1	8" x 26⅝" x 5"
SH-1	Optional Straw Holder for CTLD	5" x 4⅛" x 5"
TSD-1S	Surface Mounted Straw Holder	6" H x 3½" Dia.

CTLD SERIES CUP, LID & STRAW ORGANIZERS

Countertop or surface mount units feature quality stainless steel construction and adjustable dividers to accommodate multiple cup & lid sizes. Each model can be ordered with or without the optional SH-1 Straw Holder.



▽ COUNTERTOP COFFEE SLEEVE DISPENSERS



SLV-H-1CL



SLV-H-1BT



SLV-10BT

Model Number	Item Description	Dimensions H x W x D
SLV-H-1CL	Coffee Sleeve Dispenser Clear Acrylic	10" x 6½" x 4½"
SLV-H-1BT	Coffee Sleeve Dispenser Black Polystyrene	10" x 6½" x 4½"
SLV-10BT	Spring Loaded Coffee Sleeve Dispenser - Black Polystyrene	12" x 5¾" x 3¾"

SLV SERIES COFFEE SLEEVE DISPENSERS

These countertop units provide a simple and effective means for storing and dispensing coffee sleeves. The SLV-10BT features a spring loaded design with suction cup feet and can be used in both horizontal and vertical dispensing applications.

▽ DROP-IN TRASH CHUTES



TTC-2BT



TTC-3BT



TTC-4BT

Model Number	Item Description	Dimensions H x Diameter	Cut-Out Dimensions
TTC-2BT	Drop-in Small Trash Chute	6 $\frac{1}{8}$ " x 7 $\frac{1}{4}$ "	6 $\frac{1}{4}$ "
TTC-3BT	Drop-in Medium Trash Chute	6 $\frac{1}{8}$ " x 9 $\frac{1}{4}$ "	8 $\frac{1}{4}$ "
TTC-4BT	Drop-in Large Trash Chute	6 $\frac{1}{8}$ " x 11 $\frac{1}{4}$ "	10 $\frac{1}{4}$ "

TTC SERIES TRASH CHUTES

Drop-in trash chutes feature quality polystyrene construction. Units have smooth edges and an open bottom.

Units are available in small, medium and large diameter sizes for a variety of counter configurations and trash receptacle sizes.



DISPENSE-RITE®

Export Representatives:

E.D.A. International Corp.

4907 SW 75th Ave.

Miami, FL 33155 , USA

Phone: (305) 669-1894

Fax: (305) 669-1797

e-mail : sales@edainternational.com

www.edainternational.com



PROUDLY MADE IN USA

